

HTL2840 | CE

4.0 Ton Two-post Lift with Base

Automatic solenoid lock release, 24V full automatic control, PRO arm with 85mm min. height

4000KG
Lifting Capacity

85mm
Min. Height

1935mm
Max. Lifting Height

OVERALL DIMENSION

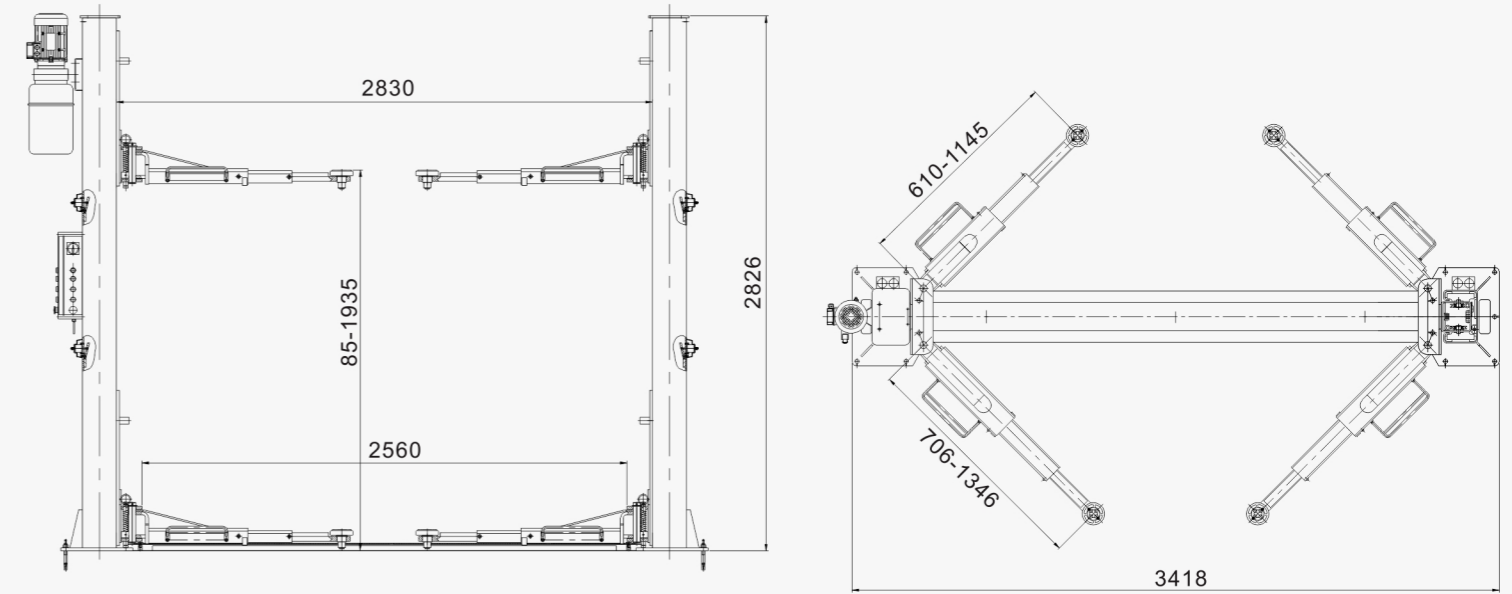

SPECIAL FEATURES

- Bottom pulley with sealed roller bearing.
- Long mechanical life guarantee.
- 4x3-stage low professional arm, 85mm pick-up.
- DLF (Direct Lowering Feature) system.

TECHNICAL DATA

Model	HTL2840
Lifting Capacity	4000kg
Min. Height	85mm
Max. Lifting Height	1935mm
Drive Thru	2560mm
Short Arm Length	610-1145mm
Long Arm Length	706-1346mm
Lifting/Lowering Time	55S/45S
Motor Power	2.2kW
Power Supply	220V/380V (Dual Voltage)

Quick & Go

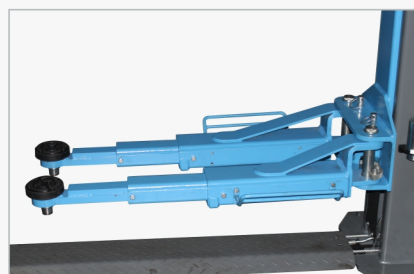
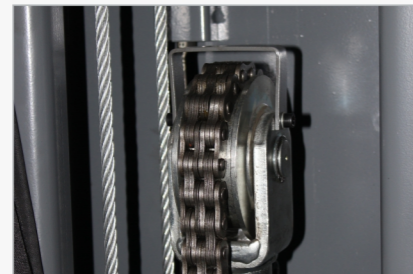
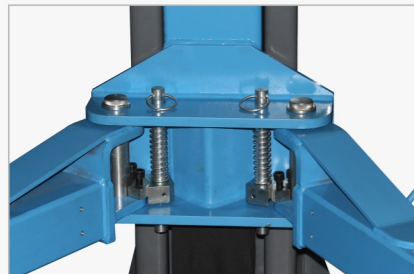

HTL 2850

Min. 110mm

Max. 1900mm

5000kg Capacity



5.0 Ton Two-post Lift with Base

Automatic solenoid lock release, reinforcement bar



Technical Features



Control
24V low voltage control box with UP, DOWN, LOCK, MAIN POWER SWITCH



Lifting Arms
Symmetric 3+3 stages lifting arms



Lifting Pad
Drop-in type dual stage threaded lifting arm pads

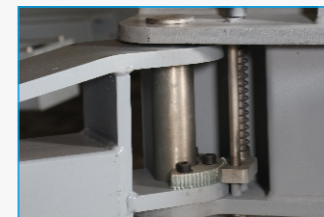

Arm Locks
Automatic arm locking during lifting and automatic unlocking when the arm reaches the floor

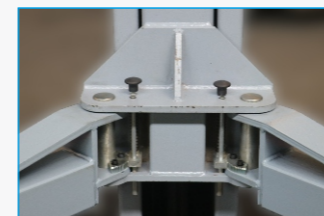

Arm Holder
C-type enclosed arm holder give more strength and safety

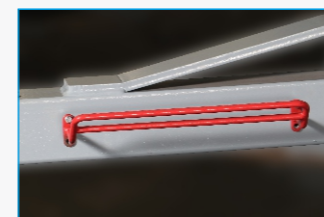

Foot Protection
Lifting arms equipped with foot protection bars



Reinforcement Bar
Reinforcement bar for bad concrete floor



Power Pack
Power pack with aluminum motor

Technical Drawing

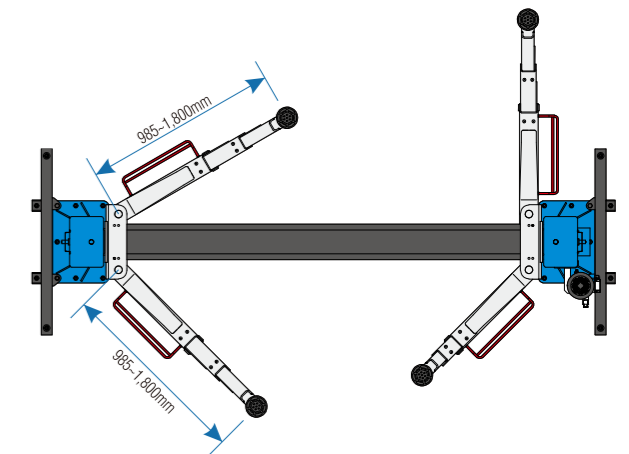
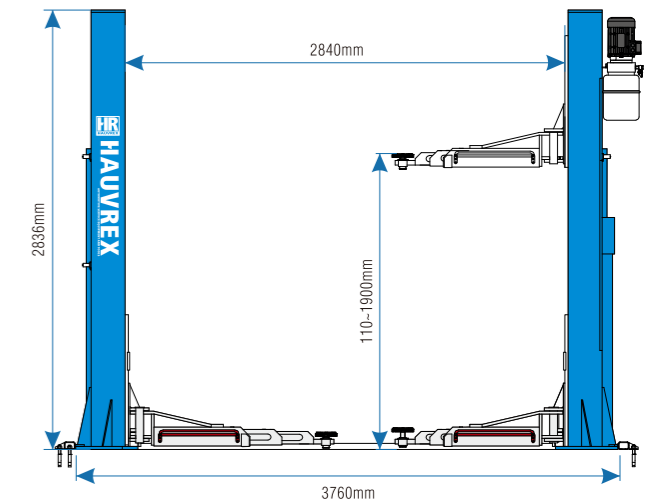

Technical Data

Lifting Capacity	5,000kg
Min. Height	110mm
Max. Lifting Height	1,900mm
Overall Height	2,836mm
Overall Width	3,760mm
Width between Posts	2,840mm
Lifting Arm Length	985-1,800mm
Lifting/Lowering Time	55Sec./45Sec.
Motor Power	3.0kW
Power Supply	380V/50Hz/3Ph 220V/50Hz/1Ph



HXL 6435YM

Min. 105mm

1930mm Max.

3500kg Capacity

3.5 Ton Low Profile Scissor Lift

With patented mechanical synchronization device



Technical Features



Control

Control cabinet with UP, Down button, main power switch, emergency stop button, power indication light and buzzer



Drive-on Ramp

Drive-on ramps which can be locked on level as platform extension

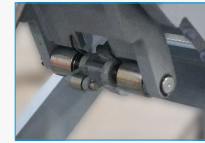

Synchronization

Patented mechanical synchronization device which stops lowering while any of two platforms are blocked

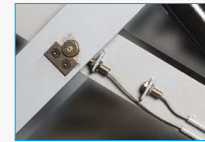

Limit Switch

Sensor type up limit switch and lowering limit switch with buzzer warning

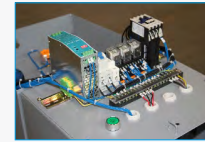

One-key Leveling

One-key leveling button inside control box makes leveling of platforms simple

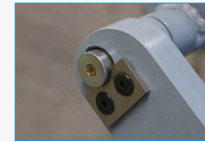

Grease Point

Grease point on all shafts to reduce wear out of components

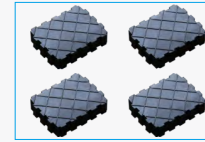

Rubber Pad

A set of four rubber pads as standard accessory

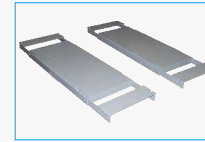

Draw-out Extension

Dual side draw-out extension version is available for in-ground installation

Technical Drawing

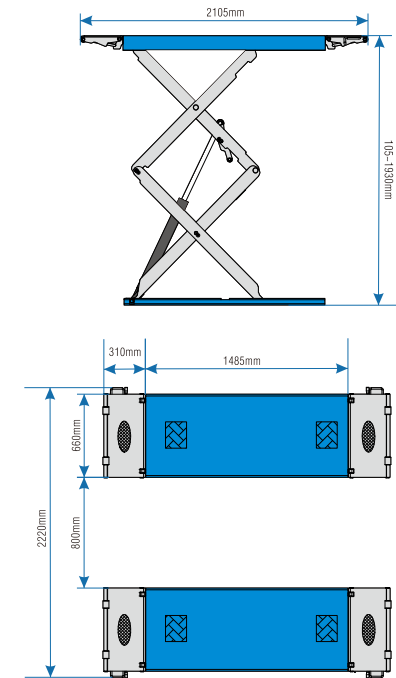

Technical Data

Lifting Capacity	3,500kg
Min. Height	105mm
Max. Lifting Height	1930mm
Platform Length	1,485mm
Platform Width	660mm
Distance between Platforms	800mm
Lifting/Lowering Time	55Sec./45Sec.
Motor Power	2.2kW
Power Supply	380V/50Hz/3Ph 220V/50Hz/1Ph

Electro-hydraulic Motorcycle Lift

foot unlock, manual lowering

1.0 Ton Motorcycle Scissor Lift

Optional: Side Platform Extensions & Ramps

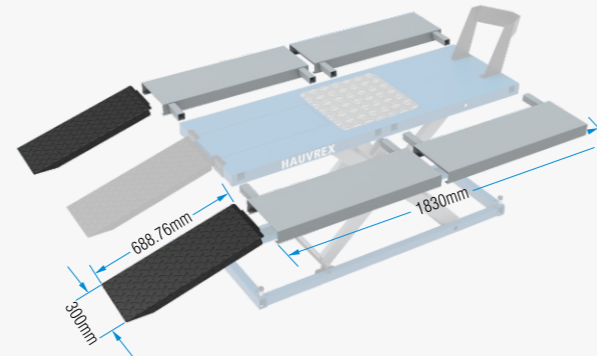

Optional: Wheel/Dolly Kit (2 rollers+1 moving bar) (2 rollers+1 moving bar)



Optional: Side Platform Extensions & Ramps

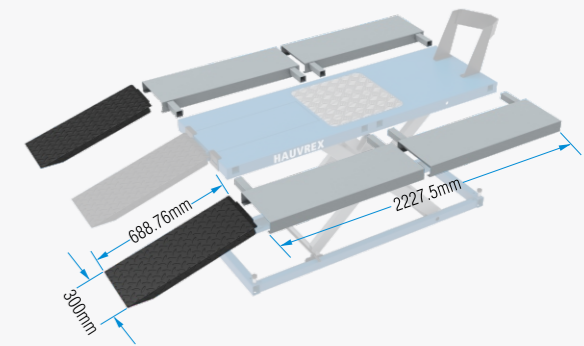

Optional: Wheel/Dolly Kit (2 rollers+1 moving bar) (2 rollers+1 moving bar)



Front wheel chock



Removable Back Plate



Foot Lock Release



Hand-held Remote Control



Built-in Power Unit

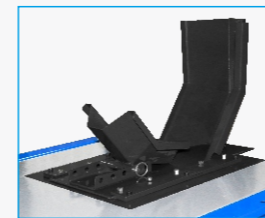

Removable front wheel chock

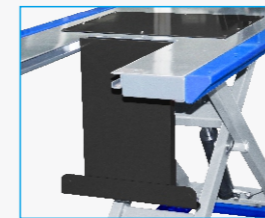

Removable Back Plate

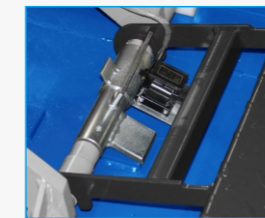

Solenoid Lock Release



Hand-held Remote Control



Nice-Looking Power Unit

Built-in hydraulic pump.
Hand held remote control.
Specifically designed for normal motorcycles.
Fully electrical and hydraulic, no air needed!
Removable back plate for rear wheel changing
Innovative foot safety lock activating device.
Skid proof diamond plate approach ramp.
Loading ramp included.
Optional accessories: side platform extensions & ramps.

Technical Data

Load Capacity	300 kg
Min. Height	210 mm
Max. Lifting Height	900 mm
Platform Length	1,830 mm
Platform Width	600 mm
Motor Power	1.5kW
Power Supply	380V/50Hz/3Ph 220V/50Hz/1Ph

Specifically designed for heavy motorbike and/or low ground clearance.
Fully electrical and hydraulic, no air needed!
At driving the front wheel into the chock the smart swivel-down mechanism locks the motorcycle.
The front wheel chock can be mounted at various positions on the table also for motorbikes with a wheelbase of 2.5 meters.
Removable back plate for rear wheel changing
Removable front wheel chock enables the user to easily remove the front forks.
Innovative automatic safety lock activating device.
Skid proof diamond plate approach ramp.
Hand-held remote control.

Technical Data

Load Capacity	1.0 Ton
Min. Height	170 mm
Max. Lifting Height	1,200 mm
Platform Length	2,227.5 mm
Platform Width	890 mm
Overall Length	2,878 mm
Motor Power	1.5kW
Power Supply	380V/50Hz/3Ph 220V/50Hz/1Ph

Pneumatic Wheel Lifter

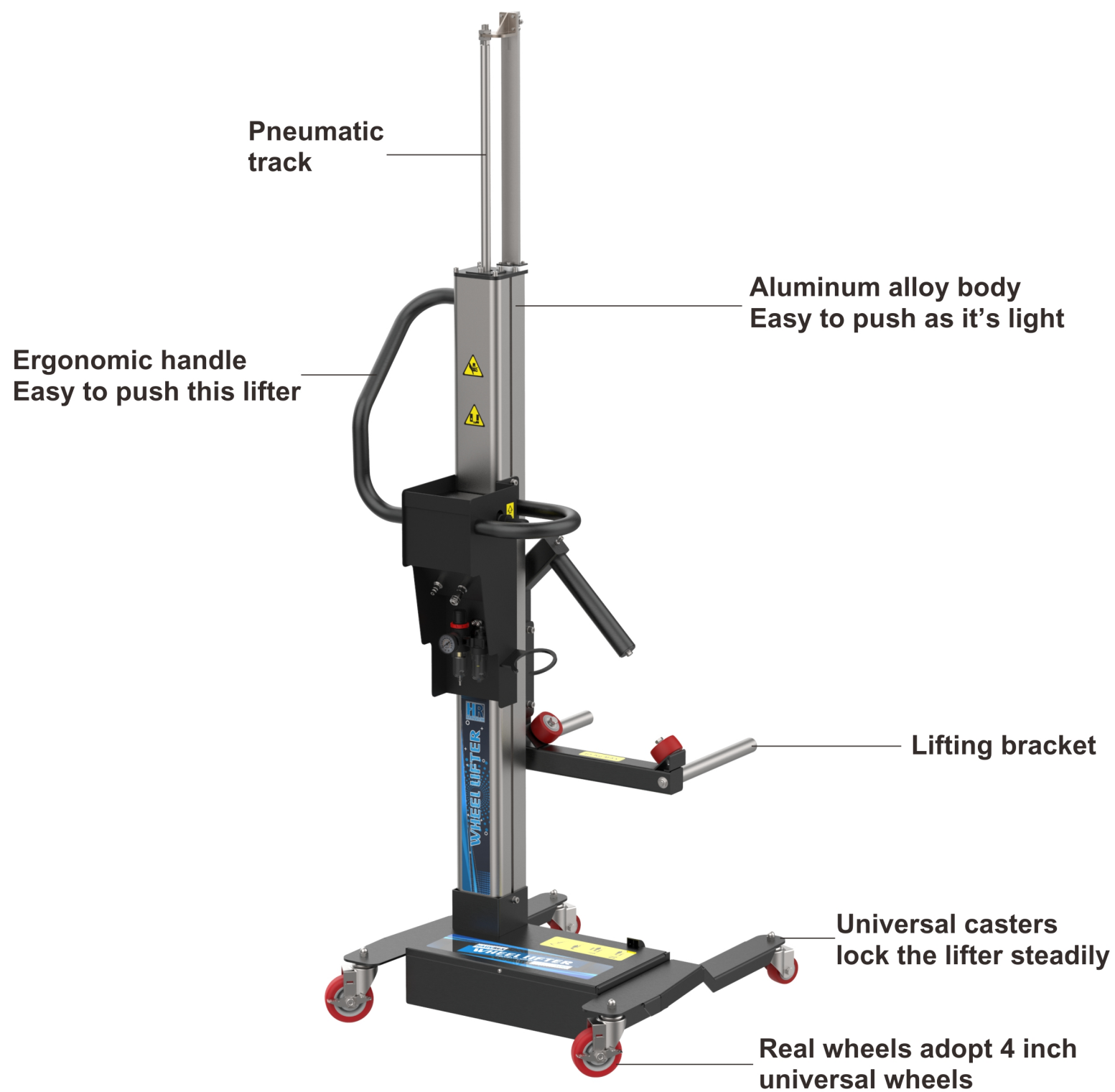

max.lifting weight	the speed of lifting	lifting height	lifting peak	input pressure	the lifting accuracy	lifting time	packing dimension
65KG	≤0.2m/s	1.2M	2.8M	6-10 Bar	2mm	12-16s	1660*550*460mm

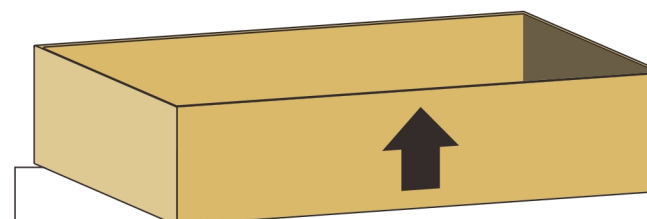
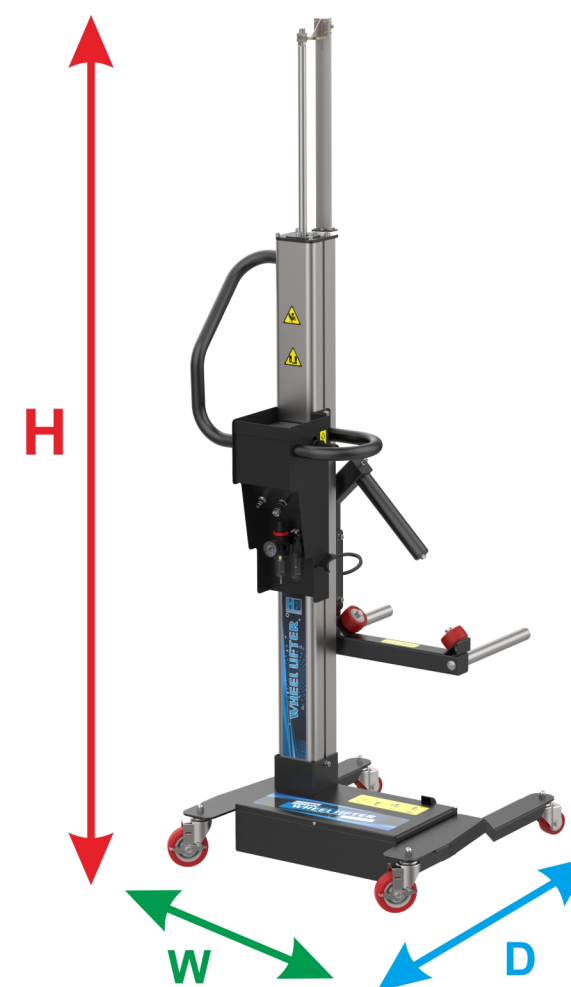

Size of outer packing box

length: 1660mm
G.W.: 66 KG width: 550mm
N.W. : 42 KG height: 460mm

H : 2800mm
D : 740mm
W : 700mm



Security tiedown



Air inlet and air outlet for pneumatic tools



Control joystick

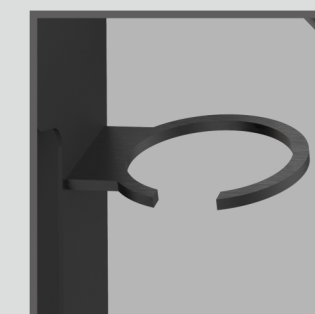

Storage rack for pneumatic tools



Automatic Tilt Column Car Tire Changer

With premium DP30 helper arm, for rims up to 28"



▶ IT type: Bead Seater (Tubeless Inflator)

Technical Features

- ▣ Automatic tyre changer with pneumatic tilt-back tower.
- ▣ Robust Ø41mm hexagon shaft.
- ▣ Simultaneous pneumatic locking of the horizontal and vertical arms with automatic positioning of the head in the optimal work position.
- ▣ Tool head with interchangeable plastic parts for rim protection.
- ▣ Pneumatic tilting arm support column featuring high torsional rigidity in all operation positions.
- ▣ Clockwise and anticlockwise rotation of the turntable through electric motor.
- ▣ The pedal assembly can be removed allowing easy servicing.
- ▣ Protection kit for bead breaker shoe, demounting head and clamping jaw comes standard.
- ▣ Independent tire inflation bay with inflation tube, pressure gauge and pressure release button.
- ▣ Complete with lubrication filter and pressure regulator.
- ▣ **DP30 helper arm:**
 - » Rotating arm with bead pressing block for drop-center rims, to assist fitting and removal of tyres, particularly low profile tyres.
 - » Tyre lifting disk to aid in demounting difficult tyre and wheel combinations.
 - » Mid-position roller helps loosening of the second bead.



Technical Details



Stainless Tool head with interchangeable plastic parts to protect rims.

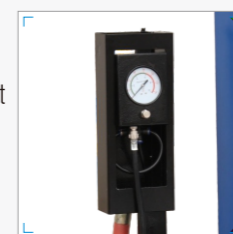

Independent tire inflation bay with inflation tube, pressure gauge and pressure release button.



Premium quality pressure regulator with water filter and lubricator.



Powerful bead breaker with 2700kg capacity.



Extractable pedal assembly for easy maintenance

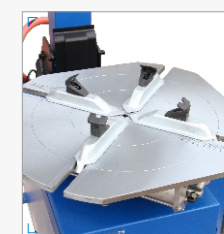

Self-centering clamping jaws specially designed for motorcycle tires



Simultaneous pneumatic locking of horizontal and vertical head arms, with automatic head positioning in the ideal working condition.



Premium right helper arm with bead pressing roller, tire lifting disk and bead pressing head

Technical Specification:

Outer Clamping Size	Inner Clamping Size	Max. Wheel Dia.	Max. Wheel Width	Beadbreaking Force	Operating Pressure	Power Supply	Motor Power
15"-28"	13"-26"	1200mm	3"-15"	2700 K6	8-10 BAR	220V/50HZ/1PH 380V/50HZ/3PH	1.5KW 1.0KW

Tyre Paste Container	Paste Brush	Tool Head Protection	Bead Breaker Protection	Claw Protection	Tyre Lever

Standard Accessories