

HXL

6435YM

Min.
105mm

1930mm
Max.

3500kg
Capacity

3.5 Ton Low Profile Scissor Lift

With patented mechanical synchronization device



CE EAC

Technical Features



Control

Control cabinet with UP, Down button, main power switch, emergency stop button, power indication light and buzzer

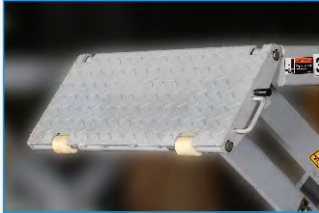

Drive-on Ramp

Drive-on ramps which can be locked on level as platform extension



Synchronization

Patented mechanical synchronization device which stops lowering while any of two platforms are blocked

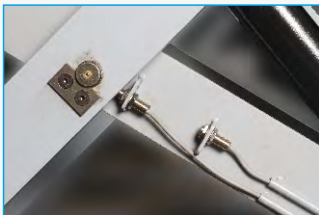

Limit Switch

Sensor type up limit switch and lowering limit switch with buzzer warning



One-key Leveling

One-key leveling button inside control box makes leveling of platforms simple

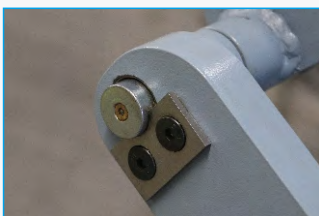

Grease Point

Grease point on all shafts to reduce wear out of components

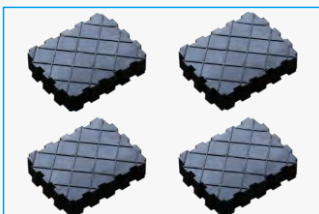

Rubber Pad

A set of four rubber pads as standard accessory

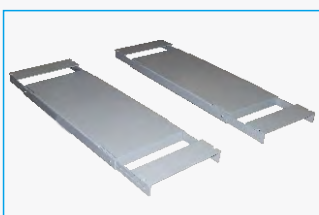

Draw-out Extension

Dual side draw-out extension version is available for in-ground installation

Technical Drawing

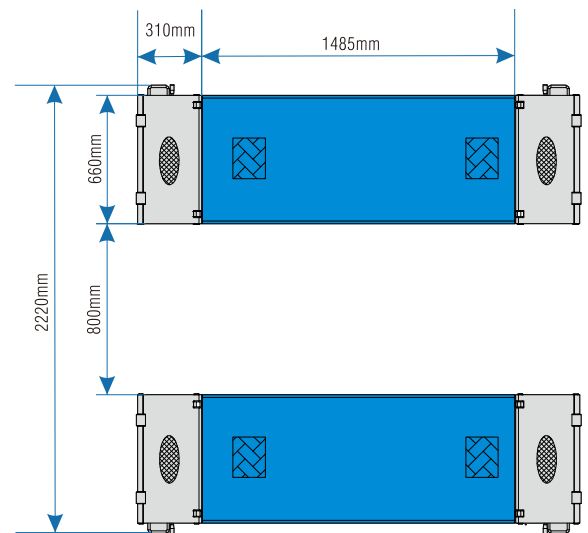
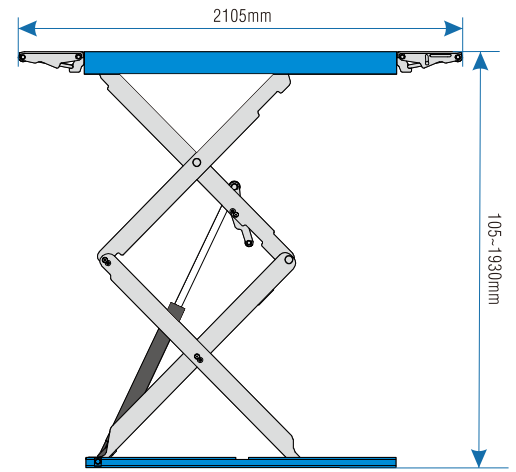

Technical Data

Lifting Capacity	3,500kg
Min. Height	105mm
Max. Lifting Height	1930mm
Platform Length	1,485mm
Platform Width	660mm
Distance between Platforms	800mm
Lifting/Lowering Time	55Sec./45Sec.
Motor Power	2.2kW
Power Supply	380V/50Hz/3Ph 220V/50Hz/1Ph